

OSRAM SFH 3605

Datasheet

Published by **ams-OSRAM AG**

Tobelbader Strasse 30, 8141 Premstaetten, Austria

Phone +43 3136 500-0

ams-osram.com

© All rights reserved



MIDLED®

SFH 3605

Silicon NPN Phototransistor in MIDLED package



Applications

- Access Control & Security
- Appliances & Tools
- Factory Automation

Features

- Package: clear silicone
- Qualifications: The product qualification test plan is based on the guidelines of AEC-Q101-REV-C, Stress Test Qualification for Automotive Grade Discrete Semiconductors.
- ESD: 2 kV acc. to ANSI/ESDA/JEDEC JS-001 (HBM, Class 2)
- Sidelooker
- Narrow half angle
- Spectral range of sensitivity: (typ) 500 ... 1100 nm
- Low profile component (1,6 mm)
- Emitter in same package (SFH 46xx) available

Ordering Information

Type	Photocurrent ¹⁾ $V_{CE} = 5\text{ V}; \lambda = 950\text{ nm};$ $E_e = 0.1\text{ mW/cm}^2$ I_{PCE}	Photocurrent ²⁾ typ. $V_{CE} = 5\text{ V}; \lambda = 950\text{ nm}; E_e = 0.1\text{ mW/cm}^2$ I_{PCE}	Ordering Code
SFH 3605-Z	112 ... 450 μA	300 μA	Q65110A1574
SFH 3605-2/3-Z	112 ... 280 μA	200 μA	Q65110A2663
SFH 3605-3/4-Z	180 ... 450 μA	300 μA	Q65110A2664

Only one bin within one packing unit.

Maximum Ratings

 $T_A = 25\text{ °C}$

Parameter	Symbol		Values
Operating temperature	T_{op}	min. max.	-40 °C 100 °C
Storage temperature	T_{stg}	min. max.	-40 °C 100 °C
Collector-emitter voltage	V_{CE}	max.	35 V
Collector current	I_C	max.	15 mA
Collector surge current $\tau \leq 10\ \mu\text{s}$	I_{CS}	max.	75 mA
Emitter-collector voltage	V_{EC}	max.	7 V
ESD withstand voltage acc. to ANSI/ESDA/JEDEC JS-001 (HBM, Class 2)	V_{ESD}	max.	2 kV

Characteristics

$T_A = 25\text{ °C}$

Parameter	Symbol		Values
Wavelength of max sensitivity	$\lambda_{S\text{ max}}$	typ.	990 nm
Spectral range of sensitivity	$\lambda_{10\%}$	typ.	500 ... 1100 nm
Dimensions of chip area	L x W	typ.	0.35 x 0.35 mm x mm
Radiant sensitive area	A	typ.	0.04 mm ²
Half angle	φ	typ.	13 °
Dark current	I_{CE0}	typ.	1 nA
$V_{CE} = 20\text{ V}; E = 0$		max.	50 nA
Rise time	t_r	typ.	7 μ s
$I_C = 1\text{ mA}; \lambda = 950\text{ nm}; V_{CE} = 5\text{ V}; R_L = 1\text{ k}\Omega$			
Fall time	t_f	typ.	7 μ s
$I_C = 1\text{ mA}; \lambda = 950\text{ nm}; V_{CE} = 5\text{ V}; R_L = 1\text{ k}\Omega$			
Collector-emitter saturation voltage ³⁾	V_{CEsat}	typ.	150 mV
$I_C = I_{PCE,min} \times 0.3; \lambda = 950\text{ nm}; E_e = 0.1\text{ mW/cm}^2$			
Capacitance	C_{CE}	typ.	1.3 pF
$V_{CE} = 5\text{ V}; f = 1\text{ MHz}; E = 0$			

Photocurrent Groups

$T_A = 25\text{ °C}$

Group	Photocurrent ¹⁾	Photocurrent ¹⁾
	$V_{CE} = 5\text{ V}; \lambda = 950\text{ nm}; E_e = 0.1\text{ mW/cm}^2$ min. I_{PCE}	$V_{CE} = 5\text{ V}; \lambda = 950\text{ nm}; E_e = 0.1\text{ mW/cm}^2$ max. I_{PCE}
2	112 μA	180 μA
3	180 μA	280 μA
4	280 μA	450 μA

Relative Spectral Sensitivity 4), 5)

$$S_{rel} = f(\lambda)$$

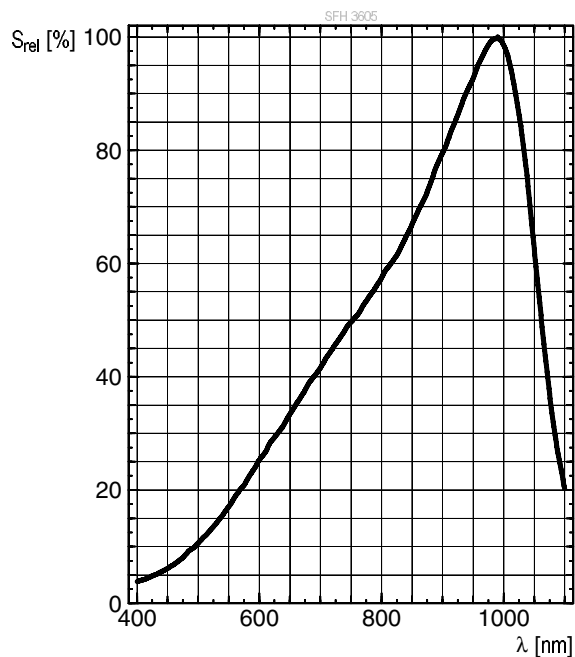

Directional Characteristics 4), 5)

$$S_{rel} = f(\varphi)$$

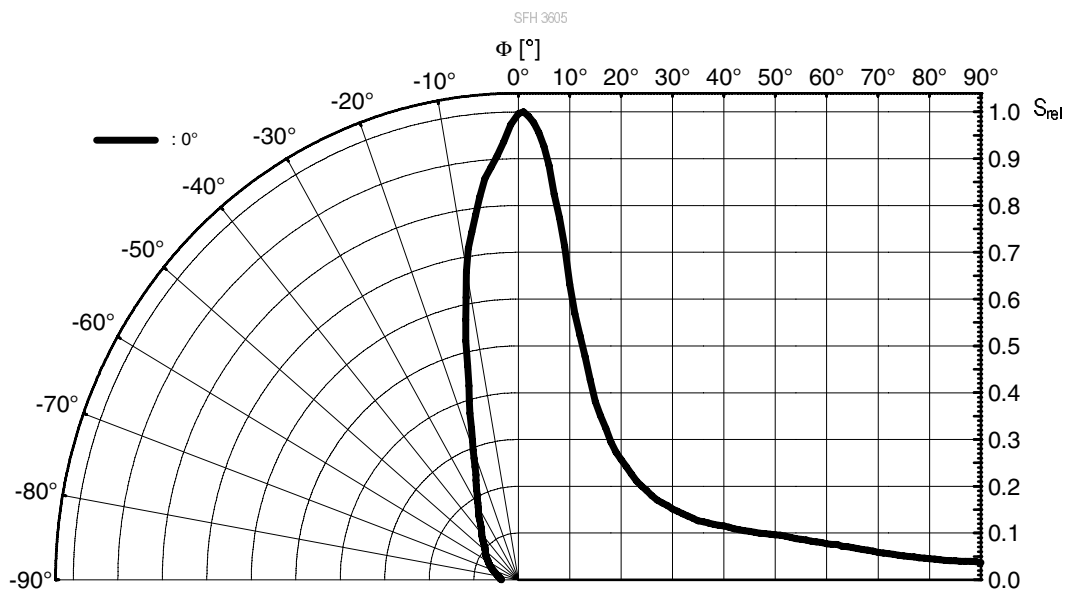

Photocurrent 4), 5)

$I_{PCE} = f(E_e); V_{CE} = 5\text{ V}$

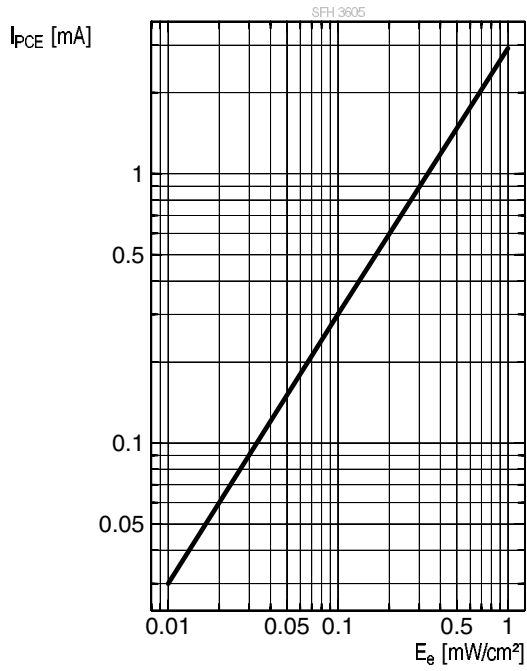

Photocurrent 4), 5)

$I_{PCE} = f(V_{CE}); E_e = \text{Parameter}$

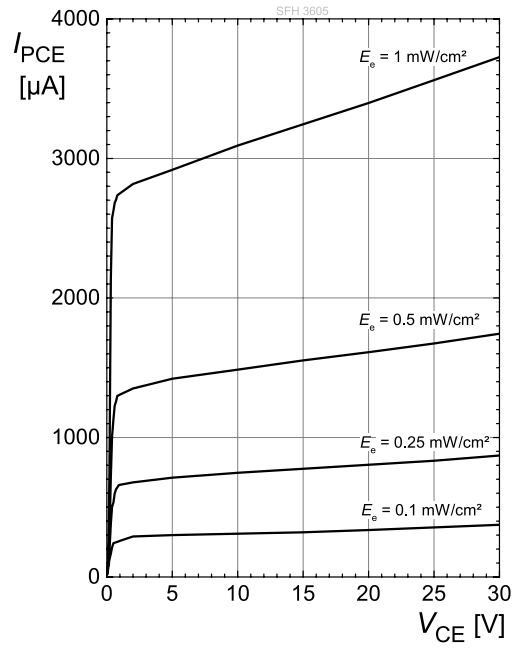

Dark Current 4), 5)

$I_{CEO} = f(V_{CE}); E = 0$

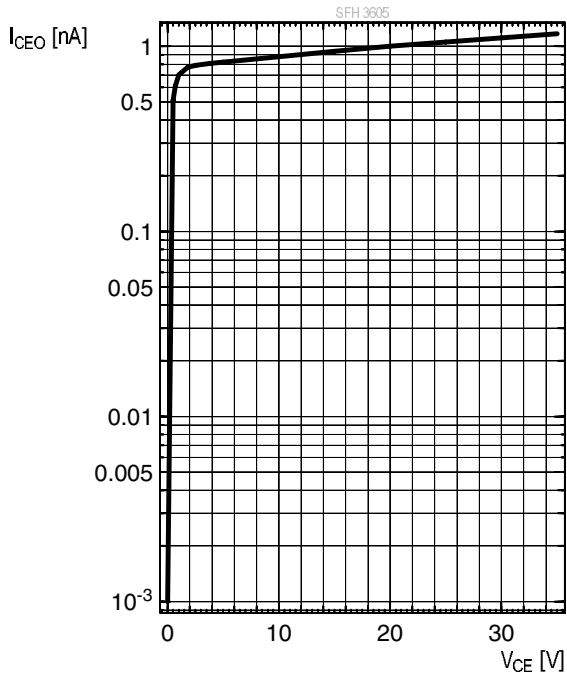

Collector-Emitter Capacitance 4), 5)

$C_{CE} = f(V_{CE}); f = 1 \text{ MHz}; E = 0$

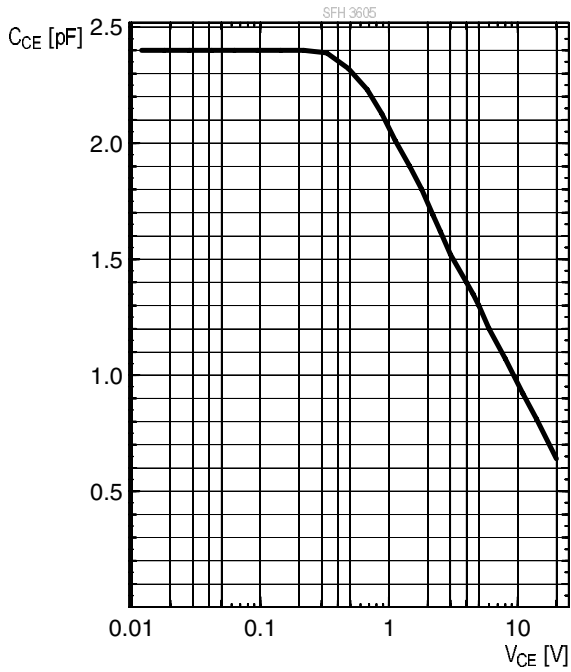

Dark Current 4)

$I_{CEO} = f(T_A); V_{CE} = 20 \text{ V}; E_e = 0 \text{ mW/cm}^2$

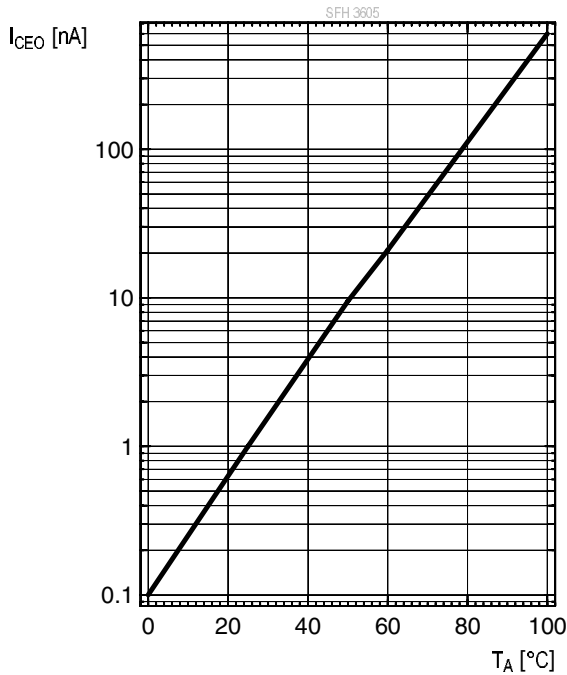

Photocurrent 4)

$I_{PCE,rel} = f(T_A); V_{CE} = 5 \text{ V}$

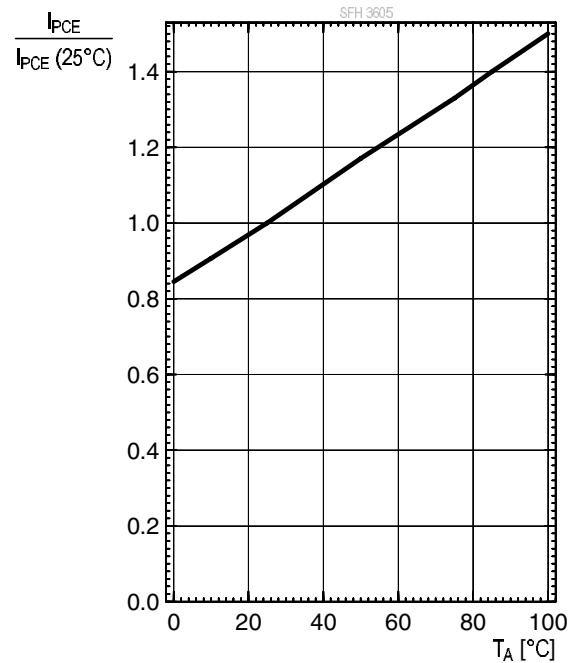

Dimensional Drawing ⁶⁾

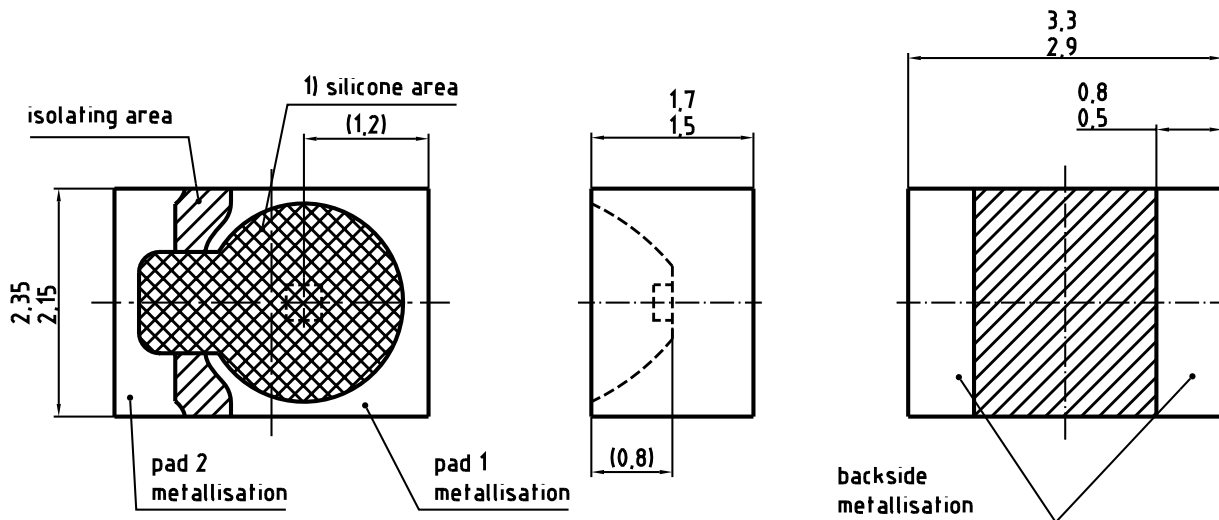

1) Device casted with silicone.
Avoid mechanical stress on silicone surface.

C63062-A3811-A1...-15

Further Information:

Approximate Weight: 23.0 mg

Package marking: Emitter

Recommended Solder Pad ⁶⁾

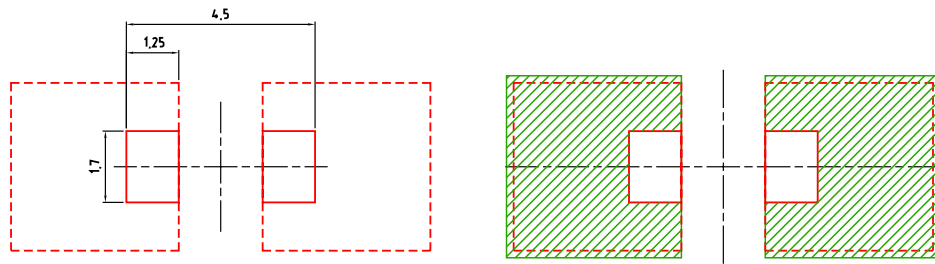

 foot print  Cu area > 16mm²

 solder resist

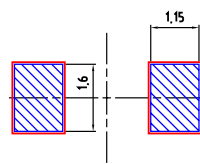

 solder stencil
recommended stencil thickness 150µm

Component Location on Pad

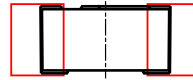

E062.3010.43-03

Pad 1: collector

Reflow Soldering Profile

Product complies to MSL Level 2 acc. to JEDEC J-STD-020E

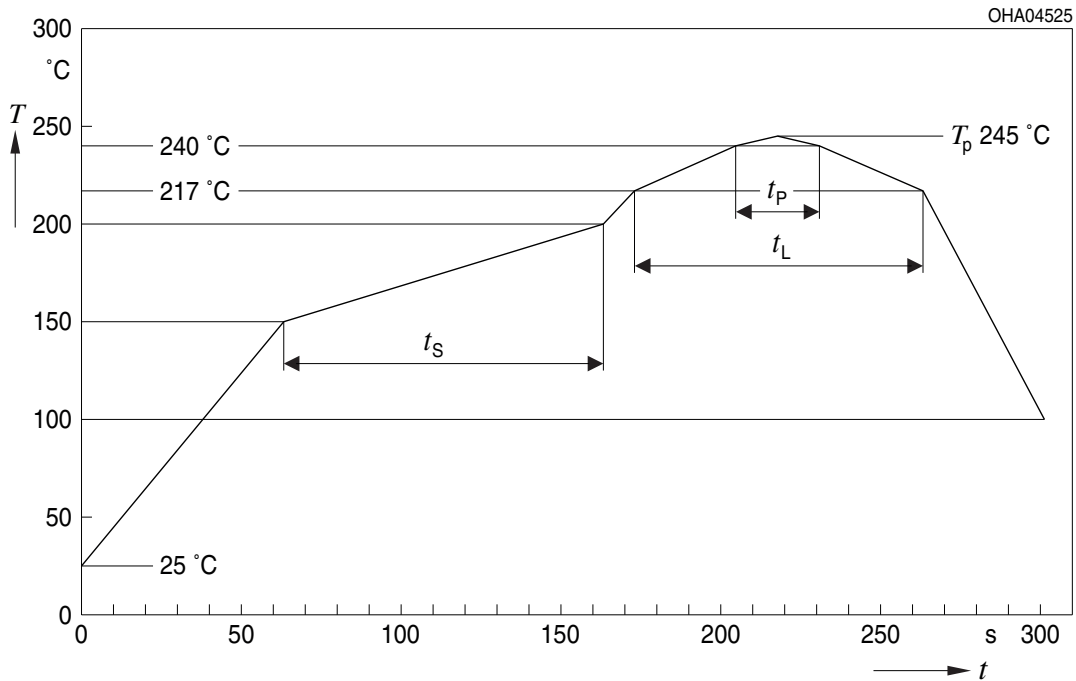

Profile Feature	Symbol	Pb-Free (SnAgCu) Assembly			Unit
		Minimum	Recommendation	Maximum	
Ramp-up rate to preheat ^{*)} 25 °C to 150 °C			2	3	K/s
Time t_s T_{Smin} to T_{Smax}	t_s	60	100	120	s
Ramp-up rate to peak ^{*)} T_{Smax} to T_p			2	3	K/s
Liquidus temperature	T_L		217		°C
Time above liquidus temperature	t_L		80	100	s
Peak temperature	T_p		245	260	°C
Time within 5 °C of the specified peak temperature $T_p - 5$ K	t_p	10	20	30	s
Ramp-down rate* T_p to 100 °C			3	6	K/s
Time 25 °C to T_p				480	s

All temperatures refer to the center of the package, measured on the top of the component

* slope calculation DT/Dt : Dt max. 5 s; fulfillment for the whole T-range

Taping ⁶⁾

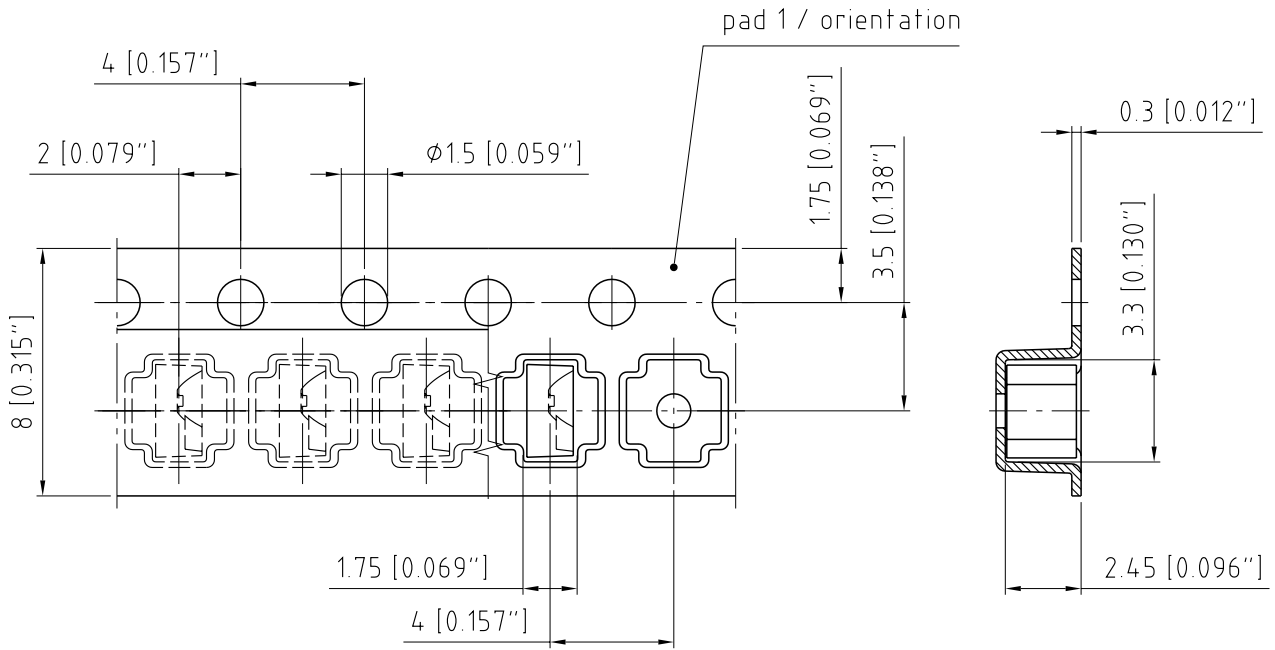

C63062-A3811-B8-08

Tape and Reel ⁷⁾

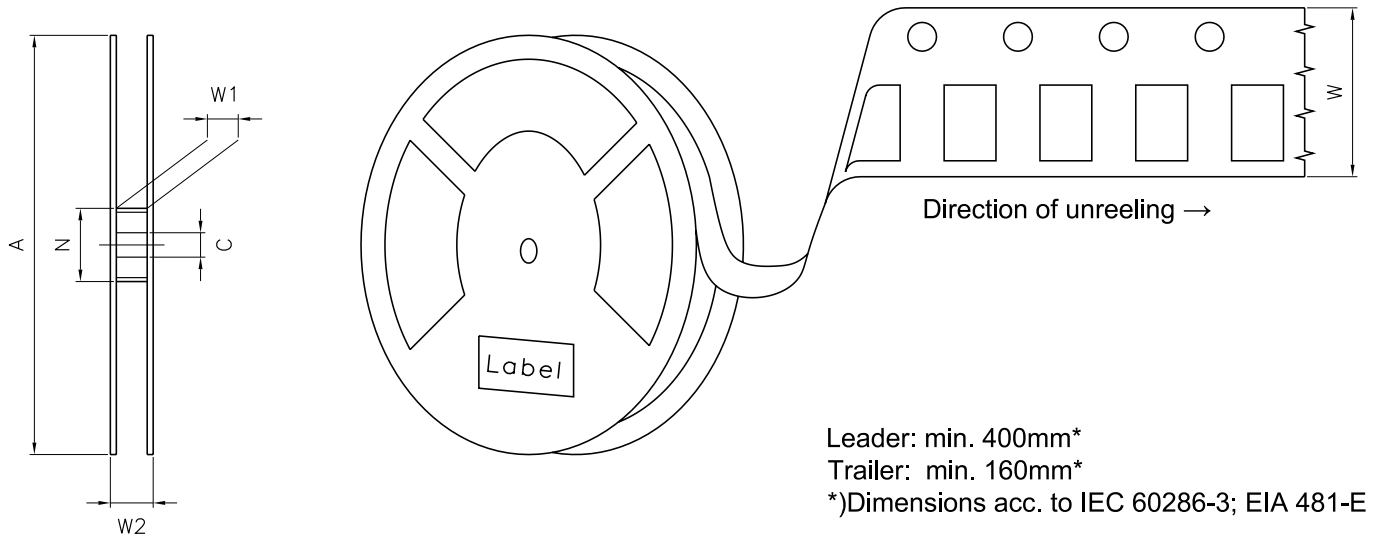

Reel Dimensions

A	W	N _{min}	W ₁	W _{2 max}	Pieces per PU
180 mm	8 + 0.3 / - 0.1 mm	60 mm	8.4 + 2 mm	14.4 mm	1600

Barcode-Product-Label (BPL)

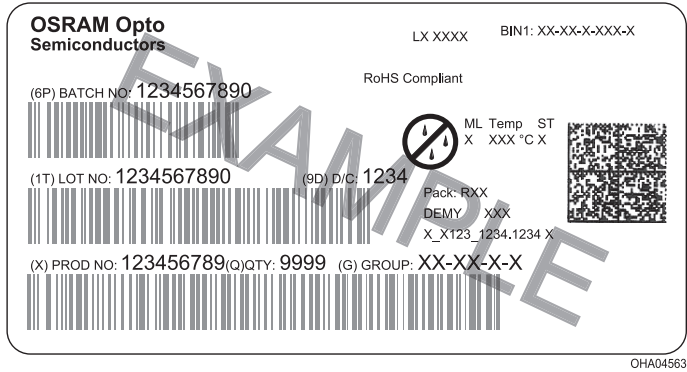

Dry Packing Process and Materials ⁶⁾



Moisture-sensitive product is packed in a dry bag containing desiccant and a humidity card according JEDEC-STD-033.

Notes

Subcomponents of this device contain, in addition to other substances, metal filled materials including silver. Metal filled materials can be affected by environments that contain traces of aggressive substances. Therefore, we recommend that customers minimize device exposure to aggressive substances during storage, production, and use. Devices that showed visible discoloration when tested using the described tests above did show no performance deviations within failure limits during the stated test duration. Respective failure limits are described in the IEC60810.

For further application related information please visit www.osram-os.com/appnotes

Disclaimer

Attention please!

The information describes the type of component and shall not be considered as assured characteristics. Terms of delivery and rights to change design reserved. Due to technical requirements components may contain dangerous substances.

For information on the types in question please contact our Sales Organization.

If printed or downloaded, please find the latest version on our website.

Packing

Please use the recycling operators known to you. We can also help you – get in touch with your nearest sales office. By agreement we will take packing material back, if it is sorted. You must bear the costs of transport. For packing material that is returned to us unsorted or which we are not obliged to accept, we shall have to invoice you for any costs incurred.

Product and functional safety devices/applications or medical devices/applications

Our components are not developed, constructed or tested for the application as safety relevant component or for the application in medical devices.

Our products are not qualified at module and system level for such application.

In case buyer – or customer supplied by buyer – considers using our components in product safety devices/ applications or medical devices/applications, buyer and/or customer has to inform our local sales partner immediately and we and buyer and /or customer will analyze and coordinate the customer-specific request between us and buyer and/or customer.

Glossary

- 1) **Photocurrent:** The photocurrent values are measured (by irradiating the devices with a homogenous light source and applying a voltage to the device) with a tolerance of $\pm 11\%$.
- 2) **Tolerance of Measure:** Unless otherwise noted in drawing, tolerances are specified with ± 0.1 and dimensions are specified in mm.
- 3) **IPCEmin:** IPCEmin is the min. photocurrent of the specified group.
- 4) **Typical Values:** Due to the special conditions of the manufacturing processes of semiconductor devices, the typical data or calculated correlations of technical parameters can only reflect statistical figures. These do not necessarily correspond to the actual parameters of each single product, which could differ from the typical data and calculated correlations or the typical characteristic line. If requested, e.g. because of technical improvements, these typ. data will be changed without any further notice.
- 5) **Testing temperature:** TA = 25°C (unless otherwise specified)
- 6) **Tolerance of Measure:** Unless otherwise noted in drawing, tolerances are specified with ± 0.1 and dimensions are specified in mm.
- 7) **Tape and Reel:** All dimensions and tolerances are specified acc. IEC 60286-3 and specified in mm.

Revision History

Version	Date	Change
1.4	2020-11-19	Schematic Transportation Box Dimensions of Transportation Box Electro - Optical Characteristics (Diagrams)
